

OPERATING INSTRUCTIONS AND SYSTEM DESCRIPTION OF THE

PDES-01DDM

PNEUMATIC DRUG EJECTION MODULE WITH DIGITAL TIMER FOR EPMS-07 SYSTEMS



VERSION 1.1
npi 2021

Table of Contents

1. Safety Regulations	3
2. EPMS-07 Modular Plug-In System	4
2.1. General System Description / Operation	4
2.2. EPMS-07 Housing	4
2.3. EPMS-H-07 Housing	4
2.4. EPMS-E-07 Housing	4
2.5. EPMS-03	5
2.6. PWR-03D	5
2.7. System Grounding	6
EPMS-07/EPMS-03	6
EPMS-E-07	6
2.8. Technical Data	6
EPMS-07, EPMS-E-07 and EPMS-H-07	6
EPMS-07 and EPMS-H-07	6
EPMS-E-07	6
EPMS-03	6
3. PDES System	7
3.1. System Description	7
3.2. PDES-01AM Components	7
3.3. Description of the Front Panel	8
4. External Valves (optional)	10
4.1. Remote Valve Plate	10
4.1. microJECT micro Valve Pipette Holder	11
4.2. Operation	12
5. Literature	14
Microinjection into Oocytes	15
Fast drug application with microJECT (EHM)	15
6. Technical Data	16

1. Safety Regulations

VERY IMPORTANT: Instruments and components supplied by npi electronic are NOT intended for clinical use or medical purposes (e.g. for diagnosis or treatment of humans) or for any other life-supporting system. npi electronic disclaims any warranties for such purpose. Equipment supplied by npi electronic must be operated only by selected, trained and adequately instructed personnel. For details please consult the **GENERAL TERMS OF DELIVERY AND CONDITIONS OF BUSINESS** of npi electronic, D-71732 Tamm, Germany.

- 1) **GENERAL:** This system is designed for use in scientific laboratories and must be operated by trained staff only. General safety regulations for operating electrical devices should be followed.
- 2) **AC MAINS CONNECTION:** While working with the npi systems, always adhere to the appropriate safety measures for handling electronic devices. Before using any device, please read manuals and instructions carefully.
The device is to be operated only at 115/230 Volt 60/50 Hz AC. Please check for appropriate line voltage before connecting any system to mains.
Always use a three-wire line cord and a mains power-plug with a protection contact connected to ground (protective earth).
Before opening the cabinet, unplug the instrument.
Unplug the instrument when replacing the fuse or changing line voltage. Replace fuse only with an appropriate specified type.
- 3) **STATIC ELECTRICITY:** Electronic equipment is sensitive to static discharges. Some devices such as sensor inputs are equipped with very sensitive FET amplifiers, which can be damaged by electrostatic charge and must therefore be handled with care. Electrostatic discharge can be avoided by touching a grounded metal surface when changing or adjusting sensors. **Always turn power off when adding or removing modules, connecting or disconnecting sensors, headstages or other components from the instrument or 19" cabinet.**
- 4) **TEMPERATURE DRIFT / WARM-UP TIME:** All analog electronic systems are sensitive to temperature changes. Therefore, all electronic instruments containing analog circuits should be used only in a warmed-up condition (i.e. after internal temperature has reached steady-state values). In most cases a warm-up period of 20-30 minutes is sufficient.
- 5) **HANDLING:** Please protect the device from moisture, heat, radiation and corrosive chemicals.

HIGH PRESSURE PRECAUTIONS: While working with PDES systems and components always adhere to the appropriate safety measures for handling high pressure pneumatic systems. Before using the PDES or any external pneumatic device please read manuals and instructions carefully.

- Always turn off pressure source before connecting or disconnecting the PDES system.
- Any component used (tubes, fittings etc.) must be specified for the maximum possible pressure.
- Do not use any aggressive, combustible or explosive gases. Only gases such as air, nitrogen, carbon dioxide, helium, etc. are allowed.
- Use only dry, oil free, filtered gases (max. 5 µm filter is allowed).
- Maximum input pressure must not exceed 8 bar (116 psi).

2. EPMS-07 Modular Plug-In System

2.1. General System Description / Operation

The npI EPMS-07 is a modular system for processing of bioelectrical signals in electrophysiology. The system is housed in a 19" rackmount cabinet (3U) has room for up to 7 plug-in units. The plug-in units are connected to power by a bus at the rear panel.

The plug-in units must be kept in position by four screws (M 2,5 x 10). The screws are important not only for mechanical stability but also for proper electrical connection to the system housing. Free area must be protected with covers.

2.2. EPMS-07 Housing

The following items are shipped with the EPMS-07 housing:

- ✓ EPMS-07 cabinet with built-in power supply
- ✓ Mains cord
- ✓ Fuse 2 A / 1 A, slow (inserted)
- ✓ Front covers

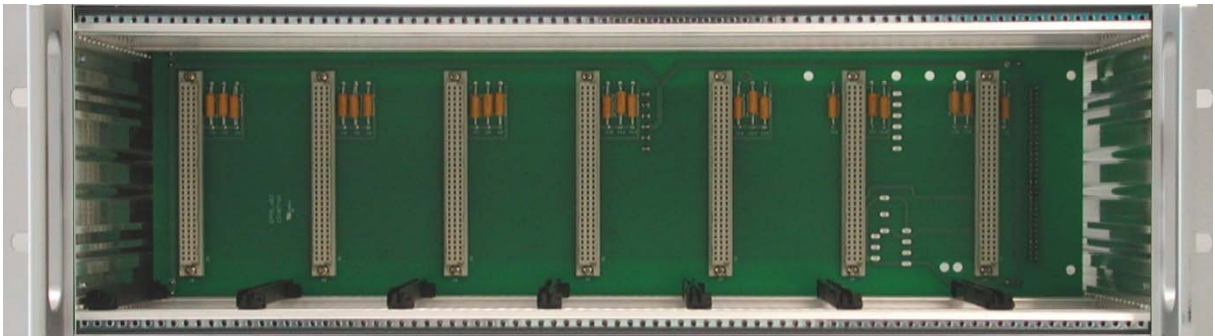

Figure 1: Left: front view of empty EPMS-07 housing.

In order to avoid induction of electromagnetic noise the power supply unit, the power switch and the fuse are located at the rear of the housing (see Figure 2, right).

2.3. EPMS-H-07 Housing

In addition to the standard power supply of the EPMS-07, the EPMS-H-07 has a built-in high voltage power supply. This is necessary for all MVCS / MVCC modules, the HVA-100, HV-TR150 and HVC-03M modules. The output voltage depends on the modules in use.

2.4. EPMS-E-07 Housing

The following items are shipped with the EPMS-E-07 housing:

- ✓ EPMS-E-07 cabinet
- ✓ External Power supply PWR-03D
- ✓ Power cord (PWR-03D to EPMS-E-07)
- ✓ Mains chord
- ✓ Fuse 1.6 A / 0.8 A, slow (inserted)
- ✓ Front covers

The EPMS-E-07 housing is designed for low-noise operation, especially for extracellular and multi channel amplifiers with plugged in filters. It operates with an external power supply to minimize distortions of the signals caused by the power supply.

2.5. EPMS-03

The following items are shipped with the EPMS-07 housing:

- ✓ EPMS-07 cabinet with built-in power supply
- ✓ Mains cord
- ✓ Fuse 034 A / 0,2 A, slow (inserted)
- ✓ Front covers



Figure 2: Left: front view of EPMS-03 housing. Right: rear panel detail of EPMS-03 and EPMS-07 housing.

In order to avoid induction of electromagnetic noise the power supply unit, the power switch and the fuse are located at the rear of the housing (see Figure 2, right).

2.6. PWR-03D

The external power supply PWR-03D is capable of driving up to 3 EPMS-E housings. Each housing is connected by a 6-pole cable from one of three connectors on the front panel of the PWR-03D to the rear panel of the respective EPMS-E housing. (see Figure 3, Figure 4). A POWER LED indicates that the PWR-03D is powered on (see Figure 3, left). Power switch, voltage selector and fuse are located at the rear panel (see Figure 3, right).

Note: The chassis of the PWR-03D is connected to protective earth, and it provides protective earth to the EPMS-E housing if connected.



Figure 3: Left: PWR-03D front panel view Right: PWR-03D rear panel view.

Note: This power supply is intended to be used with npf EPMS-E systems only.

2.7. System Grounding

EPMS-07/EPMS-03

The 19" cabinet is grounded by the power cable through the ground pin of the mains connector (= protective earth). In order to avoid ground loops the internal ground is isolated from the protective earth. The internal ground is used on the BNC connectors or GROUND plugs of the modules that are inserted into the EPMS-07 housing. The internal ground and mains ground (= protective earth) can be connected by a wire using the ground plugs on the rear panel of the instrument. It is not possible to predict whether measurements will be less or more noisy with the internal ground and mains ground connected. We recommend that you try both arrangements to determine the best configuration.

EPMS-E-07



The 19" cabinet is connected to the CHASSIS connector at the rear panel. It can be connected to the SYSTEM GROUND (SIGNAL GROUND) on the rear panel of the instrument (see Figure 4).

The chassis can be linked to PROTECTIVE EARTH by connecting it to the PWR-03D with the supplied 6-pole cable **and** by interconnecting the GROUND and PROTECTIVE EARTH connectors on the rear panel of the PWR-03D (see Figure 3). Best performance is generally achieved without connection of the chassis to protective earth.

Important: Always adhere to the appropriate safety measures.

Figure 4: Rear panel connectors of the EPMS-E-07

2.8. Technical Data

EPMS-07, EPMS-E-07 and EPMS-H-07

19" rackmount cabinet, for up to 7 plug-in units

Dimensions: 3U high (1U=1 3/4" = 44.45 mm), 254 mm deep

EPMS-07 and EPMS-H-07

Power supply: 115/230 V AC, 60/50 Hz, fuse 2 A / 1 A slow, 45-60 W

EPMS-E-07

External power supply (PWR-03D) 115/230 V AC, 60/50 Hz, fuse 1.6/0.8 A, slow

Dimensions of external power supply: (W x D x H) 247 mm x 180 mm x 90 mm

EPMS-03

Power supply: 115/230 Volts AC, 60/50 Hz, fuse 0.4 A / 0.2 A slow

Maximum current supply: 500 mA

Dimensions: 3U high (1U=1 3/4" = 44.45 mm), 245 mm deep, 265 mm wide

3. PDES System

3.1. System Description

Pressure ejection is a convenient method for applying both ionic and non-ionic solutions from micropipettes. This method is popular for two reasons. First, it can apply to almost all solutions. Second, the amount of solution ejected can be monitored by viewing the tip of the micropipette under a microscope.

npi PDES units are designed for pressure ejection of drugs in physiological and pharmacological studies. PDES systems can be equipped with high pressure outputs (up to $P_{\max} = 4$ bar / 58 psi) for drug application with fine-tipped micropipettes or with low-range pressure output ($P_{\max} = 0.7$ bar / 10 psi) for controlled droplet application from large-tipped pipettes.

The PDES-01DDM is a system with $P_{\max} = 4$ bar (58 psi) or 2 bar (29 psi). The device is designed as a module for the npi EPMS-07 system. It comprises of one channel consisting of a precision pressure regulator, an electronically controlled valve, (or a very fast micro valve located in the *microJECT*), a digital timer and a digital pressure display. Ejection of drugs can be activated manually or via a TTL input.

Mode of operation and timing is selected by controls at the front panel. If the internal timer is used, the eject time is preset by a digital potentiometer with pushbuttons. The operational status is indicated by a red/green LED.

The pressure connectors are also located at the front panel of the instrument. The injection channel is equipped with an INPUT coupling where the pressure source is connected, an OUT coupling where the injection pipette or the *microJECT* headstage, respectively, is connected. An HOLDING pressure can be applied externally in order to avoid capillary effects at the tip of the injection pipette (analogous to the "retaining" current used in iontophoretic systems). This pressure must be generated by an additional pneumatic device, like the PH-04DX. Please contact npi electronic for details. Systems with *microJECT* are additionally equipped with a connector for controlling the micro valve inside the *microJECT*.

The injection pressure is preset by a precision pressure regulator. The pressure is displayed on a digital manometer. Additional pneumatic devices (tubes, fittings, connectors, filters etc.) are available. Please contact npi electronic for details.

A calibration procedure allowing quantitative drug application is described by Hofmeier and Lux (1981), (see chapter 5).

3.2. PDES-01DDM Components

The following items are shipped with the PDES-01DDM system:

- ✓ Pressure controller module for the EPMS-07 system
- ✓ Tubing
- ✓ User manual

Optional accessories:

- ⇨ *microJECT* pipette holder (fast, switch time <1 ms)
- ⇨ Tubing
- ⇨ Ejection holder
- ⇨ Remote push button
- ⇨ External valve (slow, switch time >10 ms)

3.3. Description of the Front Panel

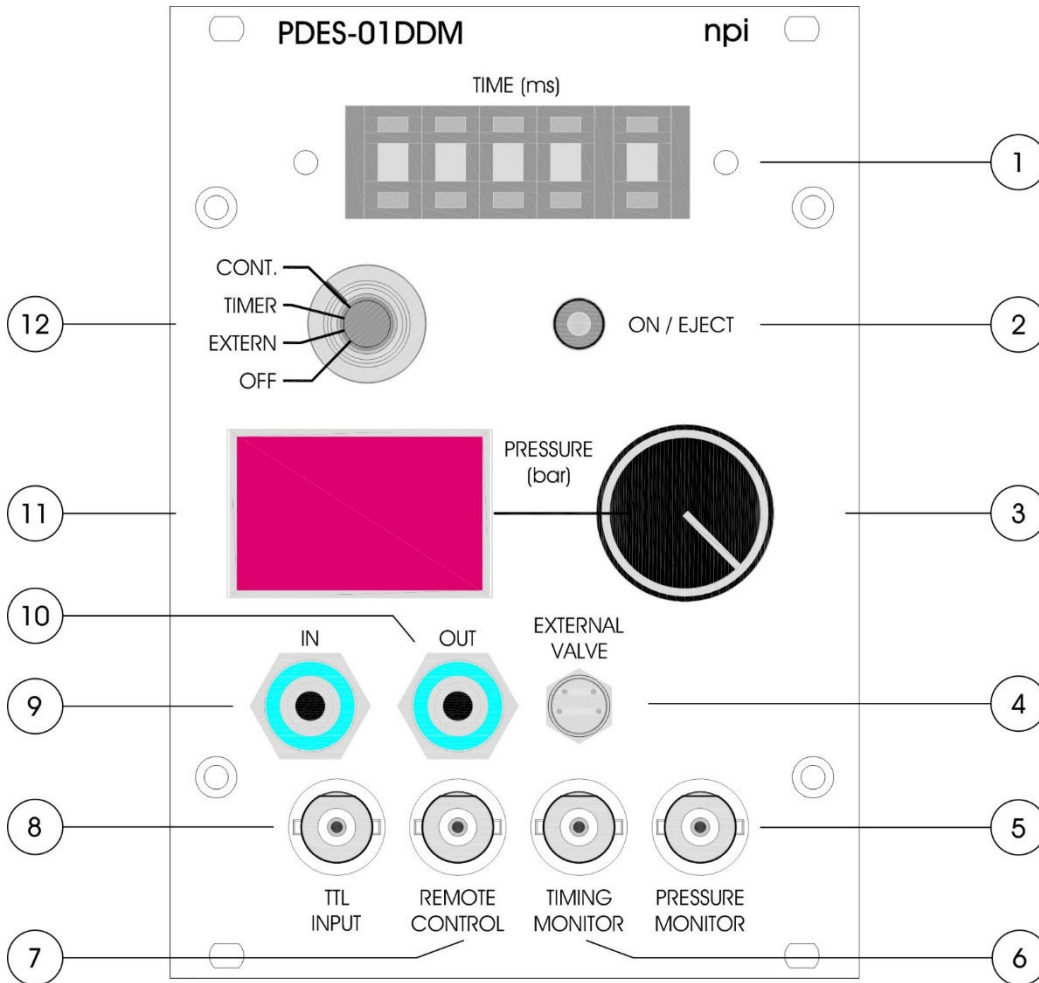

Figure 5: PDES-01DDM front panel view (the numbers are related to those in the text below)

(1) TIMER pushbutton potentiometer

Five digit pushbutton potentiometer set the ejection time (XXXX.X ms) in TIMER mode

(2) ON / EJECT LED

Indicates the operational status of the ejection channel.

red light: valve is closed, i.e. OUT connector is closed and EXHAUST connector is open.

green light: valve is open, i.e. OUT connector is open and EXHAUST connector is closed.

(3) PRESSURE regulator

Rotary knob for regulating the pressure of the ejection channel. The pressure is indicated by the manometer (#11).

(4) EXTERNAL VALVE connector (optional)

Connector for the electrical connection of the external valve.

(5) PRESSURE MONITOR

BNC connector monitoring the pressure output; sensitivity: 1 V / bar.

(6) TIMING MONITOR

BNC connector providing a TTL signal that indicates the status of the regulated injection valve (HI = valve open, LO = valve closed).

(7) REMOTE CONTROL connector

BNC connector for connecting a remote control, e.g. a pushbutton.

(8) TTL INPUT

BNC connector for connecting a TTL signal for EXTERN operation or for using the internal timer in TIMER operating mode (see also #12).

(9) IN connector

Connector for connecting the filtered, dry and oil-free gas source. The gas source must be filtered by a 5 µm filter element.

Important: Do not connect sources of OXYGEN or COMBUSTIBLE gases!!

Note: npI recommends an input pressure of 1 bar / 14 psi more than the maximum output pressure. In multiple channel systems up to 8 bar / 116 psi might be required.

(10) OUT connector

Connector for connecting the injection micropipette, or for connecting the tubing to external valve, e.g. the micropipette holder *microJECT*. The EJECT pressure is supplied to this connector.

(11) Manometer

Digital display for the pressure (X.XX bar)

(12) Operation mode switch

Switch for setting the operation mode

CONT.: The valve is open

TIMER: The internal timer is used. The timer can be started via a TTL HIGH signal at #8 or by pushing a pushbutton connected to #7

EXTERN: The valve is open as long as the input signal at #8 is HIGH or the pushbutton is pressed.

OFF: The PDES module is turned OFF, the valve is closed. LED (#2) is red. The source pressure value is still shown at the manometer #11, but opening of the valve is disabled in OFF position.

(see also chapter 4.2)

4. External Valves (optional)

External valves for the PDES system are either mounted on a remote valve plate or in the *microJECT* micro valve pipette holder.

4.1. Remote Valve Plate

The valve which is controlled by the PDES is located on the remote valve plate (see Figure 6). Tubing and cable of the external valves are connected at the front panel of the PDES system (refer to chapter 3.3). Exhaust is usually not connected.

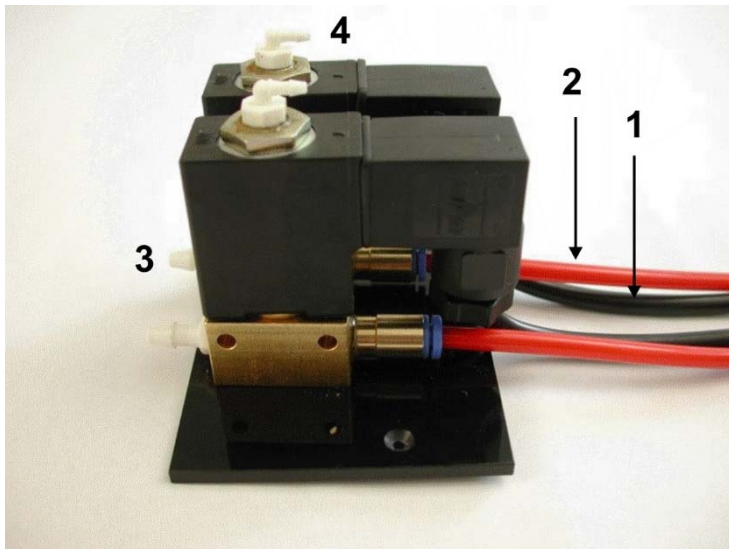

Figure 6: external valves on remote valve plate

- 1: electrical connection (black)
- 2: EJECT pressure tubing (red)
- 3: connector for ejection pipette
- 4: exhaust connector (optional)

4.1. *microJECT* micro Valve Pipette Holder

The valve which is controlled by the PDES is located in the micro valve pipette holder, called *microJECT* (see Figure 7). Tubing and cable of the *microJECT* are connected at the front panel of the PDES system (refer to chapter 3.3). Exhaust is usually not connected.

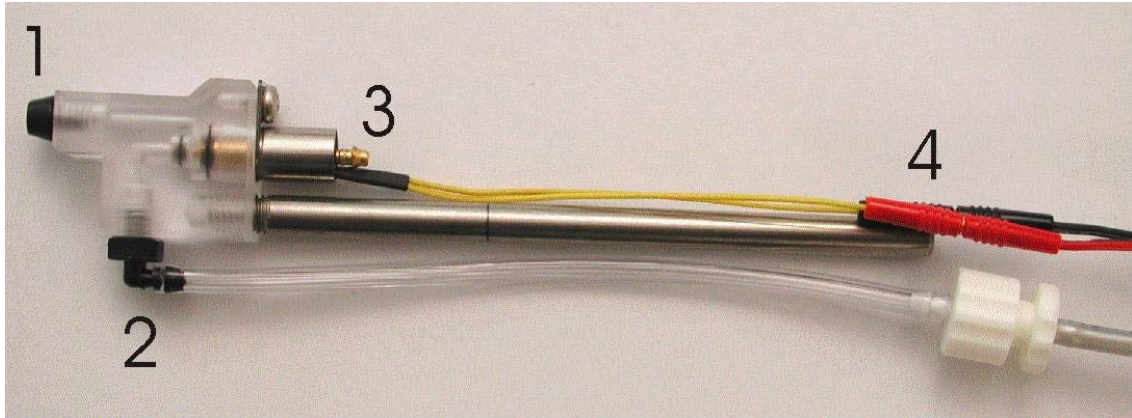

Figure 7: *microJECT*

- 1: pipette connector
- 2: connector for EJECT pressure
- 3: connector for EXHAUST pressure (optional)
- 4: electrical connection

Important: In experiments with high pressures (> 1 bar) it might be necessary to insert 2 seals into the pipette connector in order to prevent the pipette from moving.

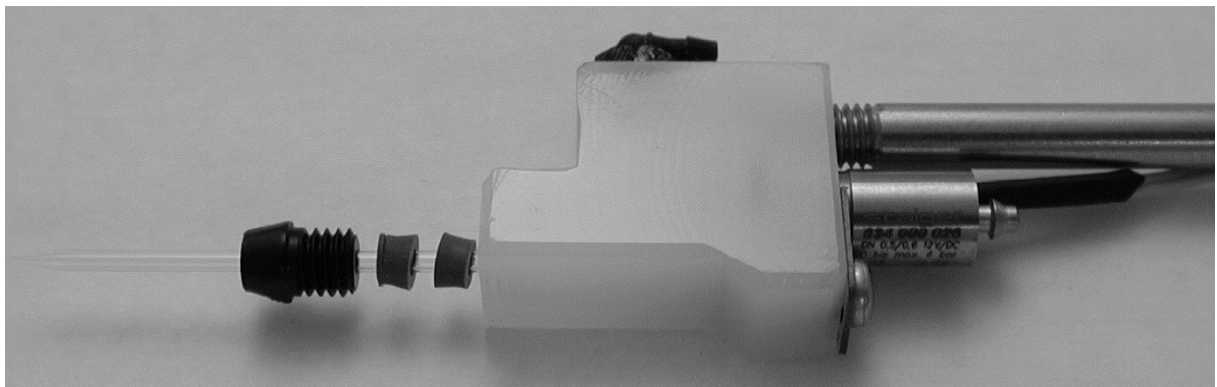

Figure 8: *microJECT* – pipette insertion

Caution: Pipettes that are not rigidly fixed in the pipette connector might be pressed out of the connector by high pressure. Always adhere to the appropriate safety measures.

4.2. Operation

- ❑ Connect the gas source (max. 8 bar) to the INPUT connector at the front panel.

Important: Do not connect sources of OXYGEN or COMBUSTIBLE gases!! The gas source MUST be dry and oil free!! Please use a degreaser and filter the gas source by a 5 µm filter element.

- ❑ Connect the injection pipette to the OUT connector at the front panel
or
- ❑ connect the *microJECT* pipette holder to the OUT connector at the front panel (#10, Figure 5) and optionally to the HOLDING pressure, and connect your ejection pipette to the *microJECT* (#1, Figure 6).
- ❑ If a low "retain" pressure (analogous to the "retaining" current used in iontophoretic systems) is required, connect the "retain" pressure source to EXHAUST at the front panel.
- ❑ Turn on pressure and adjust the pressure to the desired value using the pressure regulator (#5, Figure 5).
- ❑ Connect a timing unit to the TTL INPUT connector (#8, Figure 5) at the front panel
or
connect a pushbutton to the REMOTE CONTROL connector (#7, Figure 5) at the front panel
- ❑ The LED is green when no ejection occurs and red when the pressure is applied to the pipette.
- ❑ Select the operation mode using the rotary switch (#12, Figure 5) at the front panel.
 - In the CONT. position positive pressure is applied to the pipette continuously.
 - In the EXTERN position the duration of the application is determined directly by the duration of the TTL signal or the time the pushbutton is pressed.
 - In the TIMER position the duration is preset by TIME (ms) potentiometer (#1, Figure 5) of the PDES. Application is started with a TTL signal connected to TTL INPUT (#8, Figure 5) or by pressing the pushbutton connected to #7, Figure 5. In position OFF of the timer control for pressure ejection is disabled.
 - In the OFF position the PDES module is turned OFF, the valve is closed. LED (#2, Figure 5) is also off. The source pressure value is still shown at the manometer #11, Figure 5, but opening of the valve is disabled in OFF position.

Hint: Ejection time can be monitored by recording the signal at #8, Figure 5!

CONTINUOUS mode

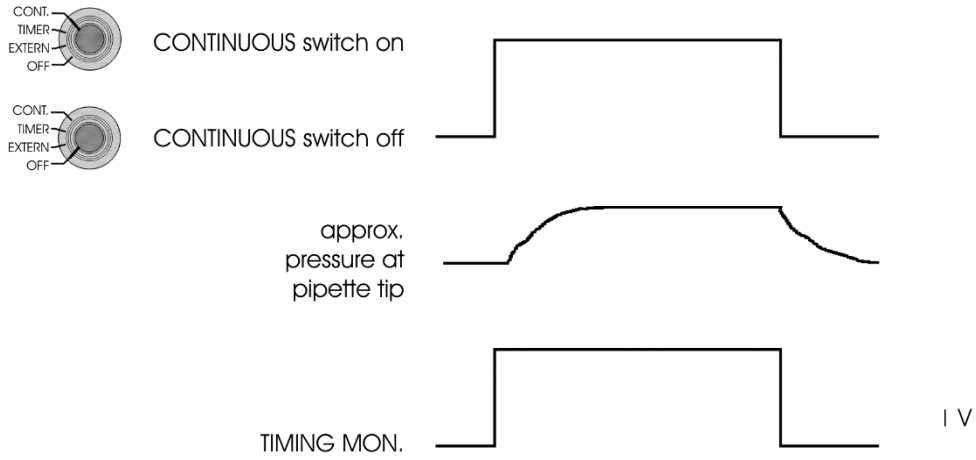

EXTERN mode

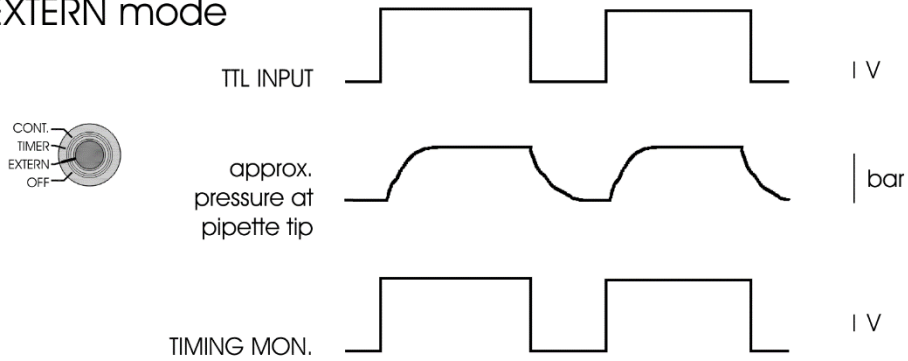

TIMER mode

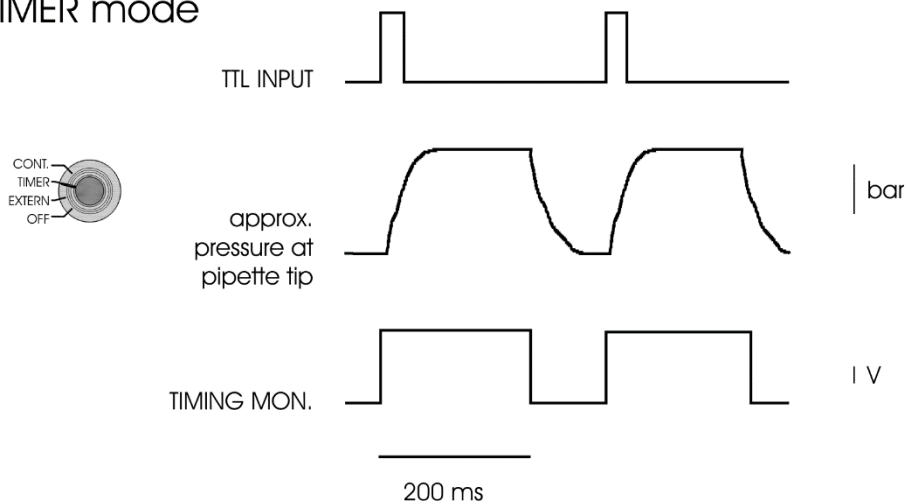

If TIMER is set to 200 ms

Figure 9: Operation modes of the PDES-01DM

5. Literature

- ❑ Bickmeyer, U., Heine, M., Manzke, T., & Richter, D. W. (2002). Differential modulation of Ih by 5-HT receptors in mouse CA1 hippocampal neurons. *Eur.J.Neurosci.* **16**, 209-218.
- ❑ Eggermann, E. & Feldmeyer, D. (2009). Cholinergic filtering in the recurrent excitatory microcircuit of cortical layer 4. *Proc.Natl.Acad.Sci.U.S.A.* **106**, 11753-11758.
- ❑ Garaschuk, O., Milos, R. I., & Konnerth, A. (2006). Targeted bulk-loading of fluorescent indicators for two-photon brain imaging in vivo. *Nat.Protocols* **1**, 380-386.
- ❑ Guzman, J. N., Hernandez, A., Galarraga, E., Tapia, D., Laville, A., Vergara, R., Aceves, J., & Bargas, J. (2003). Dopaminergic modulation of axon collaterals interconnecting spiny neurons of the rat striatum. *J Neurosci.* **23**, 8931-8940.
- ❑ Hanganu, I. L. & Luhmann, H. J. (2004). Functional Nicotinic Acetylcholine Receptors on Subplate Neurons in Neonatal Rat Somatosensory Cortex. *Journal of Neurophysiology* **92**, 189-198.
- ❑ Kilb, W., Hanganu, I. L., Okabe, A., Sava, B. A., Shimizu-Okabe, C., Fukuda, A., & Luhmann, H. J. (2008). Glycine receptors mediate excitation of subplate neurons in neonatal rat cerebral cortex. *J.Neurophysiol.* **100**, 698-707.
- ❑ Kolbaev, S. & Draguhn, A. (2008). Glutamine-induced membrane currents in cultured rat hippocampal neurons. *Eur.J Neurosci.* **28**, 535-545.
- ❑ Langer, J. & Rose, C. R. (2009). Synaptically induced sodium signals in hippocampal astrocytes in situ. *J Physiol.* **587**, 5859-5877.
- ❑ Lin, B. J., Chen, T. W., & Schild, D. (2007). Cell type-specific relationships between spiking and [Ca²⁺]_i in neurons of the Xenopus tadpole olfactory bulb. *Journal of Physiology* **582**, 163-175.
- ❑ Marandi, N., Konnerth, A., & Garaschuk, O. (2002). Two-photon chloride imaging in neurons of brain slices. *Pflugers Arch.* **445**, 357-365.
- ❑ Partridge, L.D., H.U. Zeilhofer and D. Swandulla (1998) Combined Whole-Cell and Single-Channel Current Measurement with Quantitative Ca²⁺ Injection or Fura-2 Measurement of Ca²⁺, in P.M. Conn (Ed.) Ion Channels Part B, Methods in Enzymology Vol. 293, Academic Press SanDiego.
- ❑ Ponimaskin, E., Dumuis, A., Gaven, F., Barthet, G., Heine, M., Glebov, K., Richter, D. W., & Oppermann, M. (2005). Palmitoylation of the 5-Hydroxytryptamine_{4a} Receptor Regulates Receptor Phosphorylation, Desensitization, and {beta}-Arrestin-Mediated Endocytosis. *Molecular Pharmacology* **67**, 1434-1443.
- ❑ Qiu, J., Yao, S., Hindmarch, C., Antunes, V., Paton, J., & Murphy, D. (2007). Transcription factor expression in the hypothalamo-neurohypophyseal system of the dehydrated rat: upregulation of gonadotrophin inducible transcription factor 1 mRNA is mediated by cAMP-dependent protein kinase A. *J Neurosci.* **27**, 2196-2203.
- ❑ Stepanyan, R. & Frolenkov, G. I. (2009). Fast adaptation and Ca²⁺ sensitivity of the mechanotransducer require myosin-XVa in inner but not outer cochlear hair cells. *Journal of Neuroscience* **29**, 4023-4034.
- ❑ Wolfram, V. & Juusola, M. (2004). The Impact of Rearing Conditions and Short-Term Light Exposure on Signaling Performance in Drosophila Photoreceptors. *Journal of Neurophysiology* **92**, 1918-1927.

Microinjection into Oocytes

- ❑ Wetzel, C. H., Oles, M., Wellerdieck, C., Kuczkowiak, M., Gisselmann, G., & Hatt, H. (1999). Specificity and sensitivity of a human olfactory receptor functionally expressed in human embryonic kidney 293 cells and *Xenopus Laevis* oocytes. *J.Neurosci.* **19**, 7426-7433.

Fast drug application with microJECT (EHM)

- ❑ Courjaret, R., Troger, M., & Deitmer, J. W. (2009). Suppression of GABA input by A1 adenosine receptor activation in rat cerebellar granule cells. *Neuroscience.* **162**, 946-958.
- ❑ Heck, N., Kilb, W., Reiprich, P., Kubota, H., Furukawa, T., Fukuda, A., & Luhmann, H. J. (2007). GABA-A receptors regulate neocortical neuronal migration in vitro and in vivo. *Cereb Cortex.* **17**, 138-148.

6. Technical Data

Source gas:

air, nitrogen, helium etc. no aggressive, combustible or explosive gases, filtered by a 5 µm filter element

Pressure range:

input pressure: max. 8 bar (1 bar = 10⁵ Pa)

pressure control range: 0-2 bar, or 0-4 bar,

residual air pressure: 10 mbar – 100 mbar

Input and output couplings:

hose fitting connect type for 4 mm (inner diameter) tubing

Status / EJECT time indicator:

red/green LED

red light: valve is closed (in EXTERN TIMER, CONT. and OFF operation mode)

green light: valve is open

Mode selection:

four position toggle switch, CONT., TIMER, EXTERN, OFF

Minimum valve switch time (microJECT): <1 ms

Minimum valve switch time (Kuhnke valve): approx. 10 ms

Digital timer:

100 µs – 9.9 s set by five digit thumb-wheel switch (0000.0-9999.9)

TTL INPUT:

standard BNC connector, TTL (LO = 0-2.5 V, HI = 2.5-5 V), input impedance 10 kΩ

Pulse output:

PRESSURE MONITOR: standard BNC connector, sensitivity: 1 V / bar, output impedance 249 Ω

TIMING MONITOR: standard BNC connector, TTL (LO = +0-1 V, HI = +5 V), output impedance 249 Ω